

SERVICE MANUAL

for

PureWaterCooler™

by Vertex

Model PWC-500/1000/1010/1500

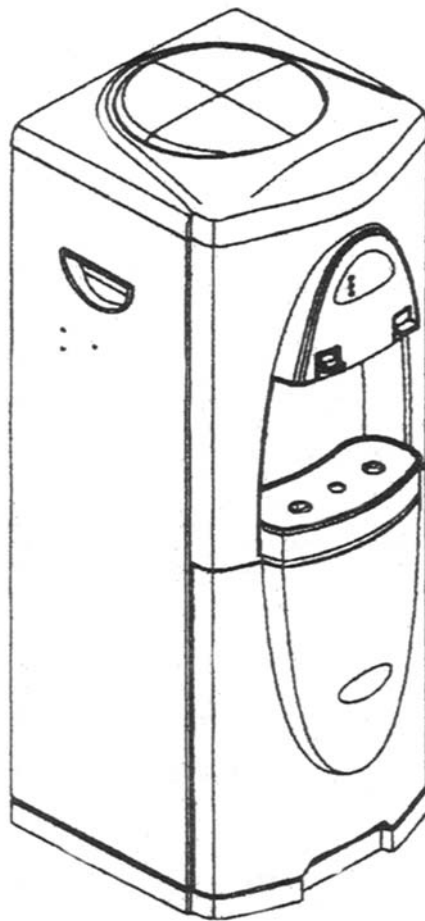

P/N man-7008

Table of Contents

- Introduction
- Cooler Set-up
- Remove Top Cover
- Remove/Replace Float
- Remove/Replace Hot Tank
- Faucet Repair
- Hot Tank Reset Button
- Remove/Replace Hot Tank Thermal Sensors
- Cold Temperature Adjustment
- Drain Cooler Tanks
- Remove/Replace Cold Temperature Switch and Sensor
- Sanitization Procedure
- Trouble Shooting
- PWC-1010 Version
- Specifications
- Cooler Exploded View
- Parts List
- Schematics

PWC-1000 Cooler

1. Introduction

The PWC-1000 line of point of use coolers are designed to give years of reliable service. The cooler has 2 spigots that dispense filtered water at 2 different temperature levels – hot and cold temperature water. The main (cold-temp) tank holds one gallon of water and is constructed of stainless steel. The cold tank can be accessed for servicing the float mechanism and for cleaning by removing the cooler main top cover (see section 4).

The hot tank is made of stainless steel and holds ½ gallon. It is important not to turn on the hot tank when there is no water in it as this will damage the heating element.

The compressor is a sealed unit and is not serviceable in the field. The compressor can be replaced by a qualified refrigeration technician with proper tools and equipment.

Please consult the factory if the compressor needs servicing.

CAUTION: *If the compressor has been stopped by switching it off or unplugging power, WAIT 10 MINUTES before turning the compressor on again. The compressor may stall and burnout if powered back on without waiting.*

The cooler makes clean water by filtration or by the reverse osmosis process. Water enters the back of the cooler and then passes through the filtration system. A feed water ball valve is located near the filters and must be turned to the on position to allow the unit to make water. Electrical power is not required for the cooler to make purified water. **CAUTION:** The carbon filtration versions of the cooler (PWC-1000F) should not be used with water hardness over 7 grains because of lime scale build up on the heating element. If hardness is higher than 7 grains, softening of the feed water is recommended or another option is to install a “phosphate” filter to the filter system.

2. Cooler Set-Up (for new cooler installation)

Feedwater/Drain Connections

-Feed Connection

2.1 Open hinged door to access filter compartment



2.5 Remove feed water plug (orange) from back of cooler.

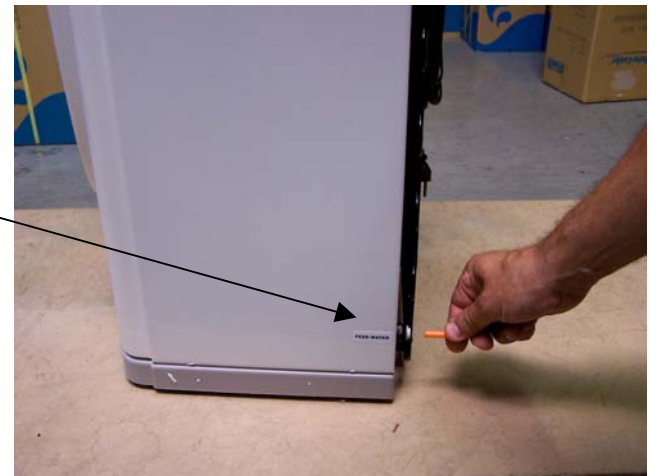

2.6 Connect supplied orange feed water tubing to feed connector on back of cooler.

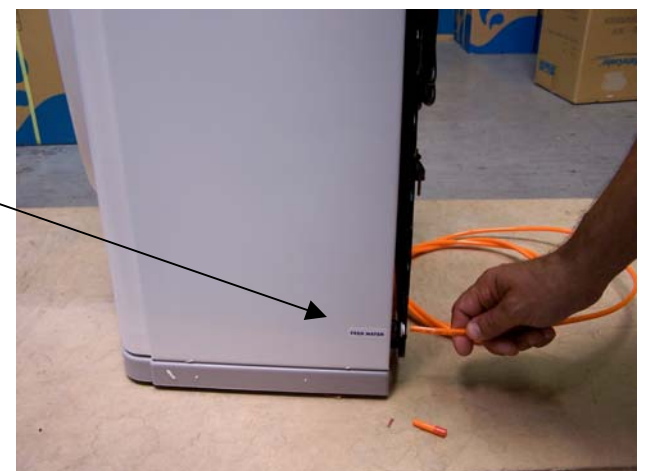

2. Cooler Set-Up cont.

- 2.4 Make feed water connection to cold water line.
A self piercing saddle valve is provided.

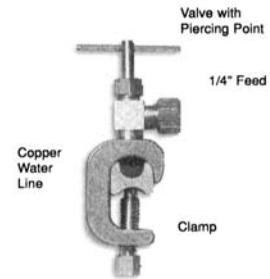
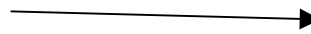

Feedwater connection (RO & filtration coolers)

(For use on copper tubing)

Use supplied self piercing saddle valve. Connect to water inlet on cooler using 1/4" tubing. Clamp saddle valve over copper feed water line (cold water line only). Tighten needle valve until tube is pierced. Retract needle 1 -2 turns to start water flow.

- 2.5 Flushing carbon fines from carbon filter.

Most carbon filters have fine particles of carbon material in the filter that will be swept into the water stream when the first water flows through the filter. Although not harmful, these carbon fines in the water are unsightly. Flush the carbon fines out of the filter before filling cooler tanks with the following procedure.



- 2.6 Remove outlet line of carbon filter (bottom)

- 2.7 Attach 3 feet of 1/4" tubing to the carbon filter outlet port (flush tubing)

- 2.8 Place flush tubing in bucket to catch water carbon fines.



2. Cooler Set-Up cont.

- 2.9 Turn on feed water at source and turn ball valve at filter to “on” to let the water flush the filter.
- 2.10 Flush until water flows clear (1 – 2 gallons)
- 2.11 Remove flush line. Reconnect tank line to outlet of carbon filter
- 2.12 **WARNING:** Do not turn on cooler hot power until cooler tanks are full of water.



-Drain Connection

- 2.9 Drain Connection (for units equipped with RO)
- 2.10 Remove drain plug (black) from back of cooler
- 2.11 Connect supplied black water tubing to drain connector on back of cooler
- 2.12 Attach supplied drain saddle to a standard 1 ½” drain pipe see fig. 1 below

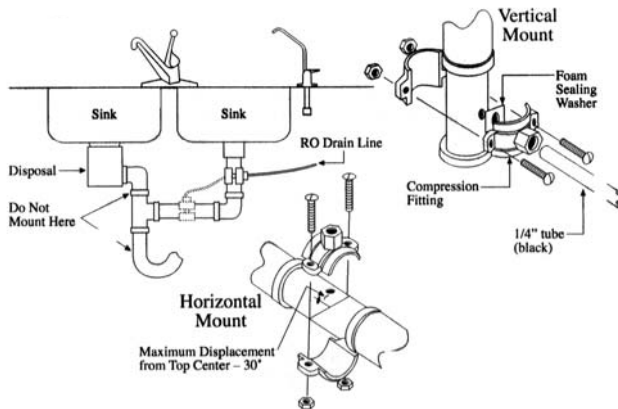

Drain saddle connection method

Drain connection required only for cooler with reverse osmosis filtration

Figure 1



RO filter set showing autovalve.
The autovalve automatically turns off the water flow when the tanks are full

3. Top Cover Removal

3.1 Remove (2) screws on back of cooler top cover



3.2 Lift cover



3.3 Cold tank is now accessible for cleaning and servicing other parts of the cooler.



3.4 Reinstall in reverse order

4. Remove/Replace Mechanical Float Valve Assembly

4.1 First, remove top cover. See Section 3

Float Valve/Level Control



4.2 Disconnect tubing from fitting



4.2 Remove elbow connector from float stem



4. Remove/Replace Mechanical Float Valve Assembly

continued

4.3 Remove nut holding float assembly to tank

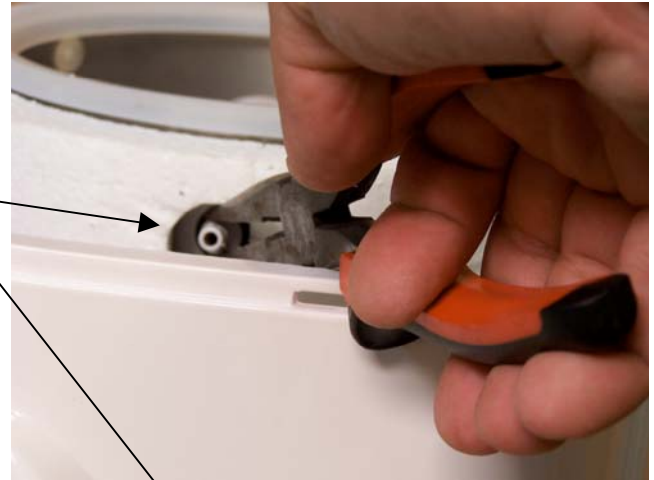

4.5 Lift out float assembly

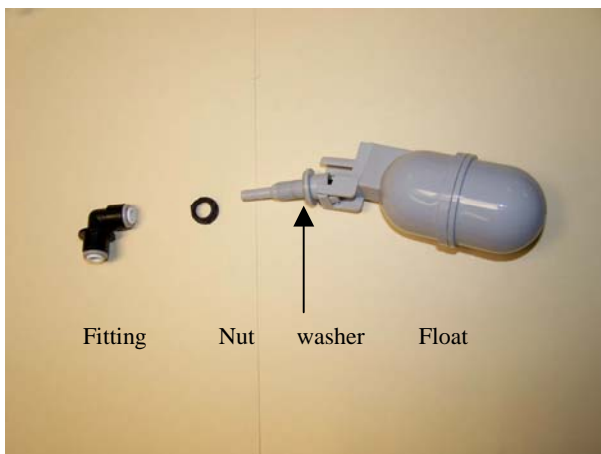
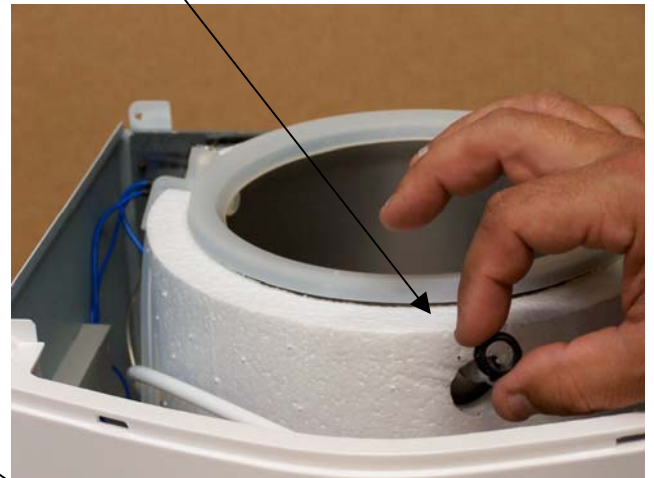

Float Assembly Parts



5. Removing/Replacing Hot Tank

5.0 Unplug power from wall

5.1 Drain water from cooler using front spigots and by removing rear drain plug

5.2 Remove top cover (section 3)

REMOVE FRONT PANEL

5.3 Remove 2 top screws from front of panel

5.4 Remove 2 screws from bottom of panel.

5.5 Remove 2 screws from back side of front panel. Requires extra long Phillips-head screwdriver.



5.6 Hold front panel in hand.



- **Removing/Replacing Hot Tank**

Cont.

5.7 Disconnect electrical connector at circuit board.

5.8 Hot tank is now accessible



5.9 Remove silicon tubing – 4 places

5.10 Disconnect 2 electrical connectors at bottom of tank

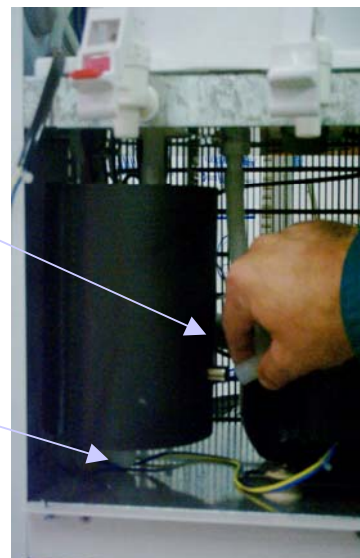

5.11 Remove (1) hot tank screw from below



- **Removing/Replacing Hot Tank**

Cont.

5.12 Remove (1) hot tank screw from above.

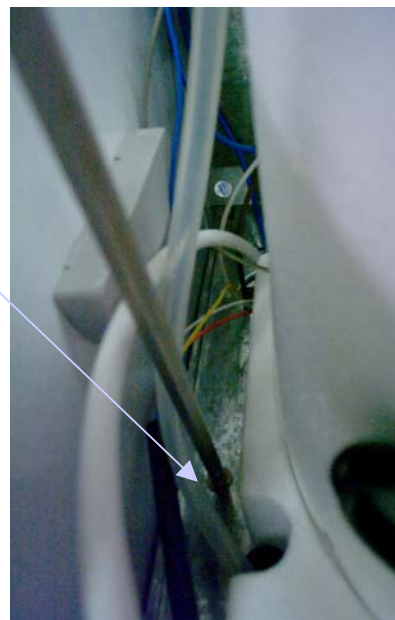

5.13 Pull hot tank down



5.14 Disconnect (4) electrical connectors from hot tank temperature sensors.

5.15 Hot tank can now be removed.

5.16 To replace the hot tank, reverse the above procedure.

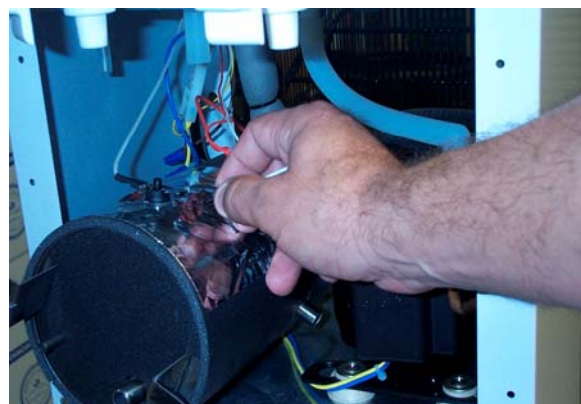

- # Dispensing Faucet Repair

6.1 Remove top cover of cooler (section 3)

6.2 For most faucet problems, the working mechanism of the faucet can be replaced without having to remove the entire faucet from the cooler. The faucet body is a one piece molded plastic part that usually does not need replacing.

6.3 To remove the working mechanism of the faucet, reach in from the top and unscrew the top nut of the faucet mechanism.

6.4. Lift out the faucet mechanism from the faucet body.



• Faucet Repair

Cont.

6.4 Lift out the lever assembly. Obtain a new lever assembly and install in the faucet base. Hand tighten the lever assembly securely.

6.5 Fill the cooler with water and check for leaks



(shown with front panel removed)

Note:

When removing and replacing the lever assembly, make sure the rubber seal and the lever are connected together. To connect the seal to the lever assembly, firmly push the seal on to the button on the lever assembly.

6.6 Reinstall the top panel.

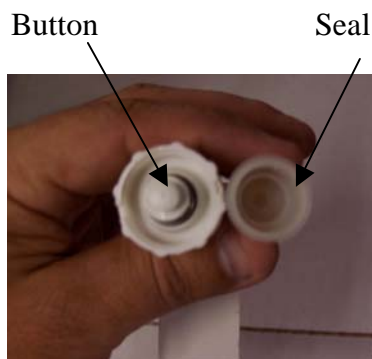

Correctly connected seal/lever assembly

7. Hot Tank Reset Button

7.0 Observe that there are two circular sensors attached to the hot tank. The lower one is the main controller at 82 °C and the upper sensor is the over-temp cut off.

The power switch for the hot tank (at the back of the cooler) should not be turned on until water can be dispensed from the hot spigot. If the hot power is turned on without water in the hot tank the heating element will over heat. To prevent this, the upper thermal sensor on the hot tank will cut power to the heating element before any damage takes place. If this happens the switch on the thermal sensor can be reset to operational mode manually by the following procedure.

7.1 Make sure the power cord is unplugged.

7.2 From the back of the cooler, find the hot tank

7.3 Find the upper thermal sensor on the hot tank

7.4 Using a long thin object such as a screw driver or a pen, depress the small black button at the center of the upper thermal switch. You should feel a click when you depress the button. This action resets the over-temp sensor.



8. Remove/Replace Thermal Sensor

8.0 The hot tank thermal sensors are located on the outside of the hot tank. There are two thermal sensors. The sensor located lower on the hot tank controls the daily operation of the heating element. The upper thermal sensor is an overheat safety switch and cuts power to the hot tank should a malfunction occur and the tank starts to overheat.

8.1 Unplug cooler from power source for this operation.

8.2 Remove (2) screws holding the upper part of the cooling grill to the cooler cabinet. Keep the rubber grommets for reassembly.

8.3 Carefully pull the cooling grill away from the cooler. The grill is still attached at the bottom. Do not move the grill more than 30 degrees away from the cooler frame or the cooling system may be damaged.

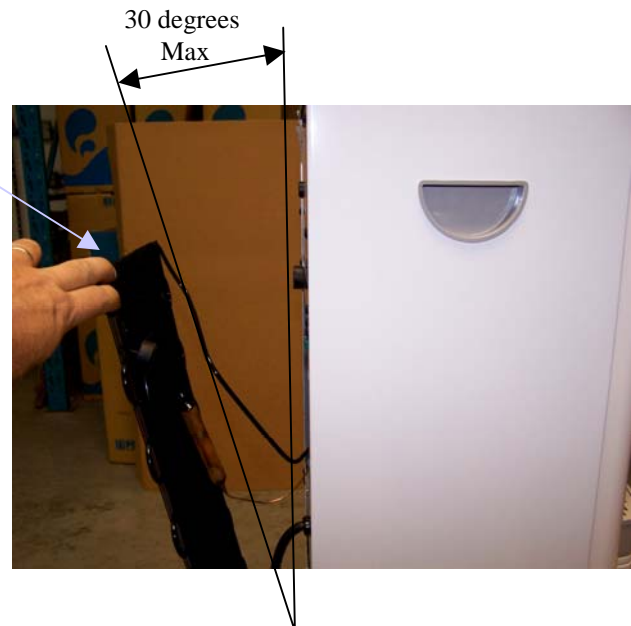

• Remove/Replace Thermal Sensor

cont.

8.4 There are (2) thermal sensors attached with screws to the hot tank. The lower sensor automatically turns the heating element on and off to maintain the water at 180 °F. The upper sensor is the over temperature sensor. This sensor activates if the temperature on the tank goes over 212 °F. If this sensor is activated due to a overheat condition, it will cut the power to the heating element. If this happens, it can be reset by pressing the button at the center of the sensor.

To check if either thermal sensor is good, use a continuity tester (ohm meter) to check for continuity across the thermal sensor. Make sure the thermal sensor is at ambient temperature for this test. If there is no continuity, replace the sensor.

8.5 To change either sensor, disconnect (2) electrical terminals from sensor.

8.6 Remove (2) screws holding sensor to tank.

8.7 Install new thermal sensor, replace screws, reconnect electrical terminals to sensor.

8.8 Carefully relocate cooling grill to original location and re-attach using rubber grommets and screws.

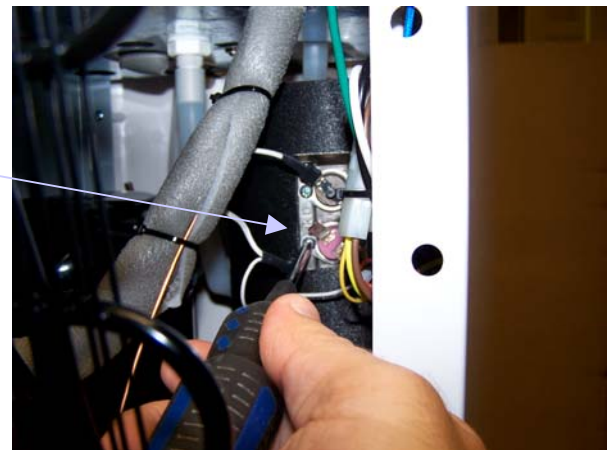
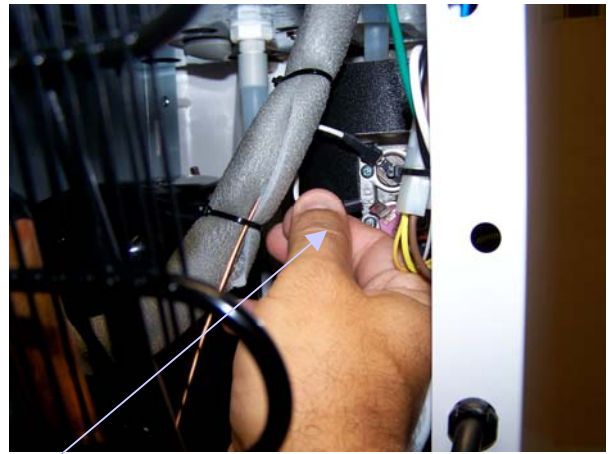

9. Cold Tank Temperature Adjustment

9.0 The cold water temperature adjustment is located on the back of the cooler on the right side. An expansion tube senses temperature in the cold tank and opens and closes the thermostat.

9.1 The cold adjustment is a shaft with a screw driver slot on the end.

9.2 To make the water colder, using a screw driver, rotate the shaft clockwise. For warmer water rotate the shaft counter clockwise. There are stops on the adjustment shaft. DO NOT force the control shaft over the stop. If this happens, it will be necessary to replace the temperature controller

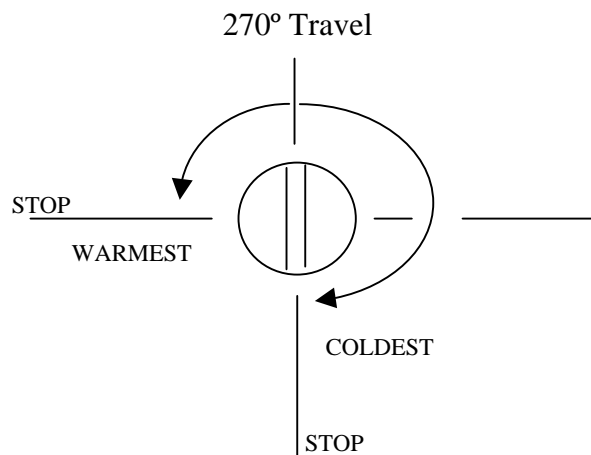

Normal Travel is 270°

10. Draining Cooler Tanks

Completely draining the tanks is required when shipping the cooler or when one the of the tanks needs replacing. This procedure will allow you to remove all the water from the cooler.

9.0 Hot and Cold Tank Drain: Using a flat head screw driver, pry the hot tank plug out until you can grasp it with your fingers.



9.1 Remove the plug with fingers.
Water will pour from the port



9.2 Drain any remaining water in the system by depressing the faucets.

11. Remove/Replace Cold Tank Sensor

11.0 The cold tank sensor is extremely reliable and rarely needs replacing. Its function is to control the cold water temperature by turning the compressor on or off as needed.

11.1 Remove the top cover of the cooler (sec. 3)

11.2 Remove the float assembly (sec. 4)

11.3 Remove the silicon rubber sealing ring



11.4 Remove the silicon over flow tube



11.5 Carefully lift off the insulating foam from the cold tank



- **Remove/Replace Cold Tank Sensor**
cont.

11.6 Cold tank cooling coils and sensor probe are now visible



11.7 Disconnect (2) wires from sensor switch

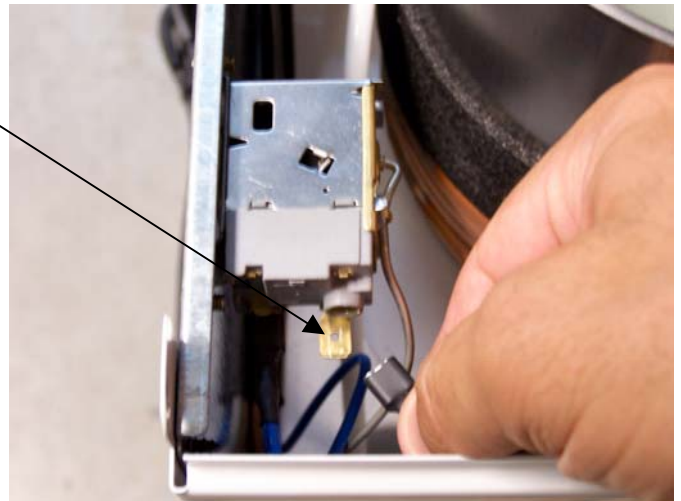

11.8 Remove (2) screws holding sensor switch body to cooler cabinet.



• Remove/Replace Cold Tank Sensor

cont.

11.9 Remove cold sensor switch and sensor tube from cooler



11.10 To remove the sensor tube, carefully pull the sensor out of the copper tube at the bottom outside of the cold tank

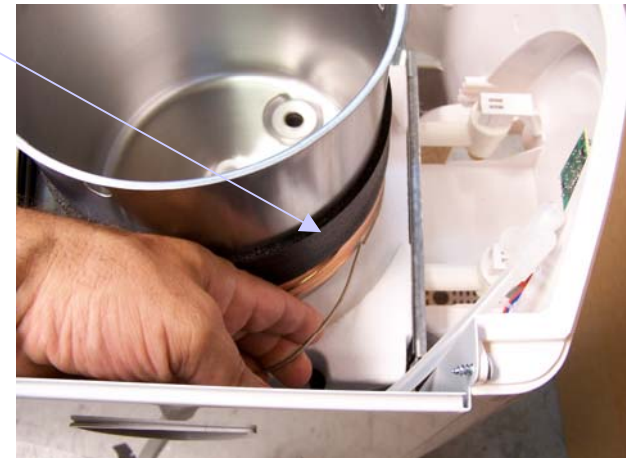

11.11 With new cold sensor, carefully install sensor tube into copper tube at bottom of cold tank.

11.12 Install the sensor switch using (2) screw to cooler cabinet.

11.13 Adjust sensor tube so it is routed close to the outside of the cold tank. This will allow the insulating foam to fit properly over the tank.

11.14 Reinstall insulating foam.

11.15 Reinstall remaining parts in reverse order.

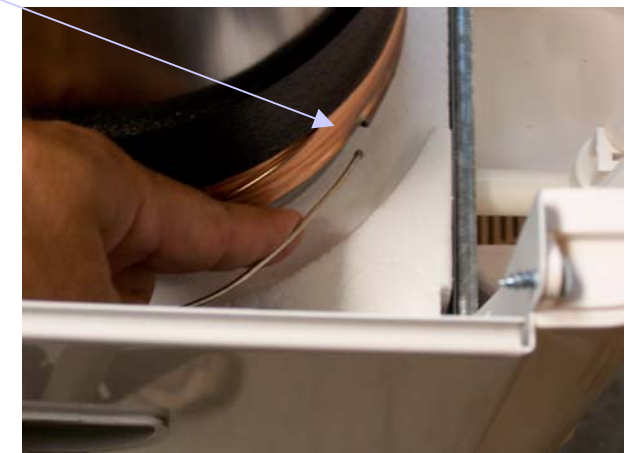

12. Sanitization Procedure

The sanitization procedure is performed to reduce/eliminate any bacteriological growth in the cooler tanks and dispensing plumbing. Bacteriological growth can be the cause of some taste and odor in the water.

The procedure is as follows:

- Mix 1 teaspoon of common household bleach (5.25%) in 2 gallons of clean water.
- Unplug the cooler from the power source.
- Drain all water from the cooler tanks.
- Pour the sanitizing solution into the main (cold temperature) tank until full.
- Open all spigots to allow sanitizing solution to fill the dispensing faucets. Close the spigots.
- Let the sanitizing solution stand in the cooler for 10 minutes.
CAUTION: Leaving the sanitizing solution in the cooler for more than 10 minutes can cause taste problems in the water.
- Completely drain the sanitizing solution from all the tanks per section 10
- Fill the main (cold temp.) tank with clear tap water to rinse out the sanitizing solution.
- Completely empty the rinse water from the tanks.
- The cooler is now sanitized and ready for filling with filtered water.

13. Trouble Shooting

Water not cold from cold tank

(Water dispenses from spigot but is not cold)

Possible causes

Solution _____.

- | | |
|------------------------------------|---|
| 1. Cooler not plugged in | Make sure power cord is plugged into wall socket |
| 2. Power switch not on | Make sure cold power switch on the back panel is on. |
| 3. Adjust temperature control | The thermostat temperature control adjustment is located on the back of the cooler. (see section 9) |
| 4. All cold water has been drained | Cooler needs time to recover. wait 10-15 minutes until water cools |

13. Trouble Shooting

Cont.

No Hot Water from Hot Tank

Possible Causes

Solution

- | | |
|---|---|
| 1. Cooler not plugged in | Make sure power cord is plugged into wall socket |
| 2. Power switch not on | Make sure Hot power switch on back panel is on and hot power light on front is illuminated |
| 3. Electrical terminal disconnected | Check to see that both wires are connected to the heating element terminals. These are located at the bottom of the hot tank |
| 4. Heating element failure due to scaling | Check for continuity across hot tank heater terminals. To do this, unplug unit from wall power. Disconnect one of the connector at the heating element terminals (at bottom of tank). Using an ohm meter, check for continuity across the 2 terminals. If there is no continuity (open), the tank must be replaced. |

13. Trouble Shooting Cont.

No Hot Water from Hot Tank cont.

<u>Possible causes</u>	<u>Solution</u>
5. Thermal sensor failure	<p>The thermal sensors are attached to the hot tank. The upper sensor is a 96 °C sensor and functions as an over heat safety. The lower sensor is a 82 °C sensor and controls the heating element function. The lower sensor would be the problem if there was no hot water. To see if the sensor is functioning properly, first unplug the cooler from the wall. remove the terminal from the sensor. Using an ohm meter, check for continuity. If there is no continuity (open), replace sensor as per section 8.</p>
6. Hot tank turned on without water in tank	<p>The hot power should never be turned on without water in the tank. If this happens, the upper thermal sensor on the hot tank will switch, cutting power to the hot tank. This is a safety device to prevent the heating element from burning itself out due to dry heating. Once the hot tank cools off the switch can be reset to operating condition. See section 7.</p>

Trouble Shooting Cont.

No Hot Water from Hot Tank cont.

An indicator of a hot tank problem can also be the lights on the front control panel. Below is a table of trouble shooting help.

If the Hot Tank is not heating and the front panel lights are:

<u>Front Panel Lights</u>	<u>Cause</u>	<u>Check</u>
Hot Power – on Heating - on	Heating element disconnected or burned out	No Continuity across heating element - Replace Hot Tank
No lights at all	Upper thermal sensor Reset button disengaged or sensor burned out	Press reset button / NO Continuity across thermal sensor -replace sensor
Hot Power – on Heating - off	Lower thermal sensor disconnected or burned out	No Continuity across thermal sensor - replace sensor

14. Model PWC-1010

The model PWC-1010 has room and cold temperature water dispensed from the two spigots. Nearly all functions and construction of the PWC-1010 cooler are the identical to the PWC-1000 (hot and cold) cooler except as follows:

1. There is no heating element in the room temperature holding tank
2. There are no power switches on the back of the cooler
3. The cold power (compressor) turns on as soon as the cooler is plugged in.
4. The indicator lights on the front of the cooler show when there is power to the compressor (cold power) and when the compressor is on (cooling).

All repair sections of this manual apply to the model PWC-1010 cooler. To remove and replace the room temperature tank refer to the section covering the hot tank in this manual (section 5).

15. Specifications

	PWC-1000	PWC-1010
Voltage/Frequency	120 VAC/ 60 Hz	120 VAC/ 60 Hz
Weight (dry)	48 lbs.	48 lbs.
Total Water Capacity	1.5 gallons	1.5 gallons
Hot tank	.5 gallons	
Cold tank	1.0 gallons	1.0 gallons
Room tank		.5 gallons
Power Consumption Total	600 Watts	100 Watts
Hot Tank	500 Watts	
Cold Tank	100 Watts	100 Watts
Room Tank		0 Watts
Temperature		
Hot	180 °F average	
Cold (adjustable)	38 °F average	38 °F average
Refrigerant	R134a 36 mg.	R134a 36 mg.

PWC-1000F/1010F Filtration Configuration

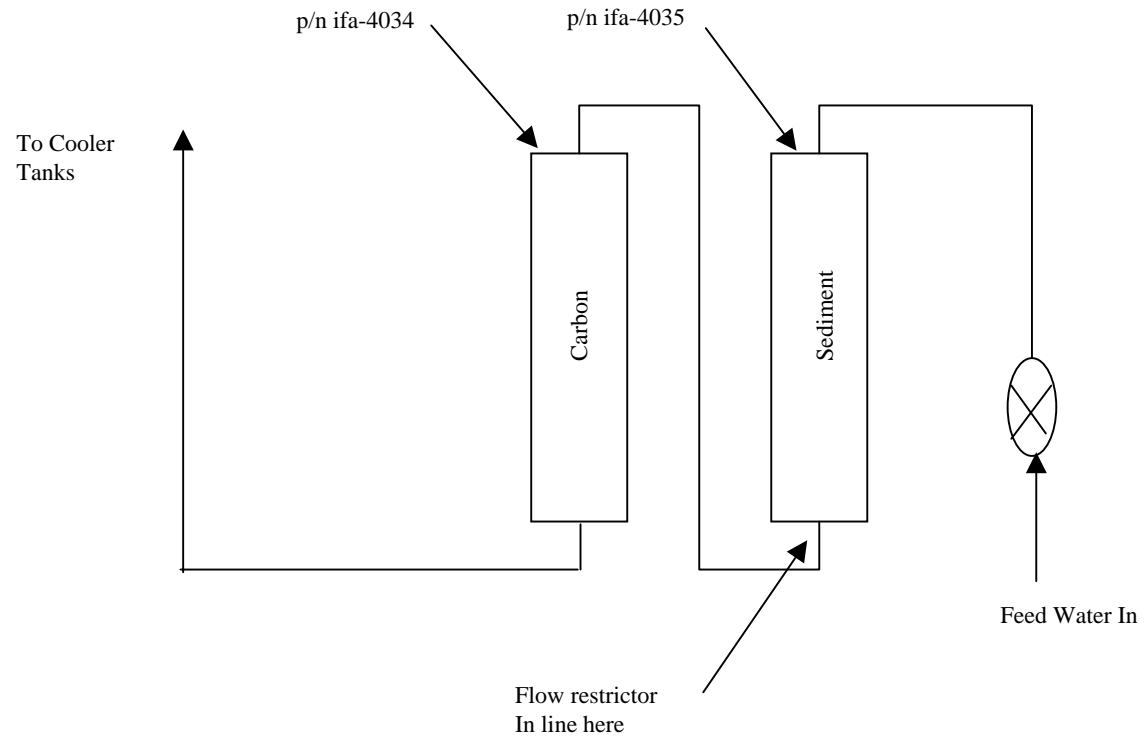

PWC-1000R/1010R RO Filtration Configuration

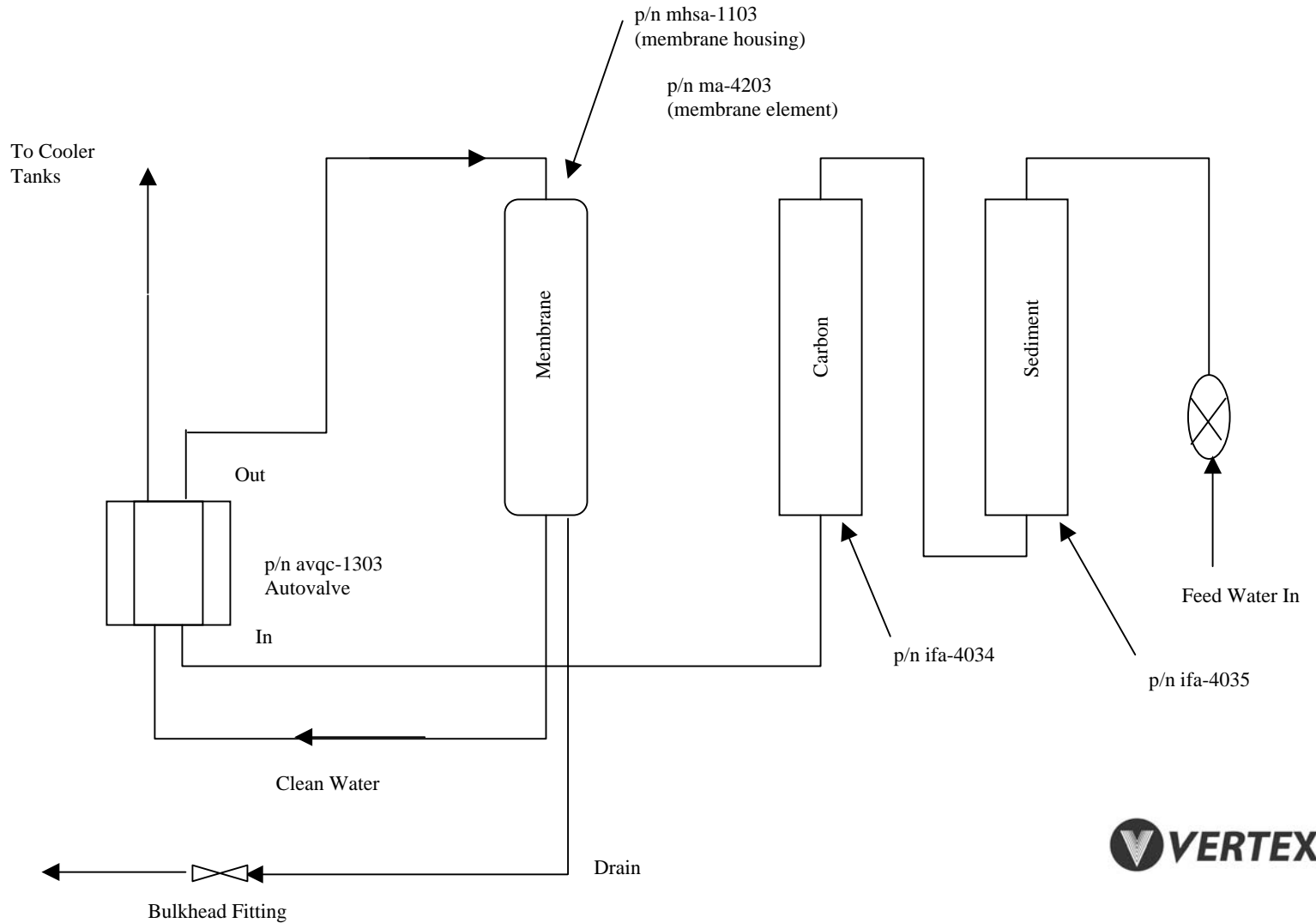

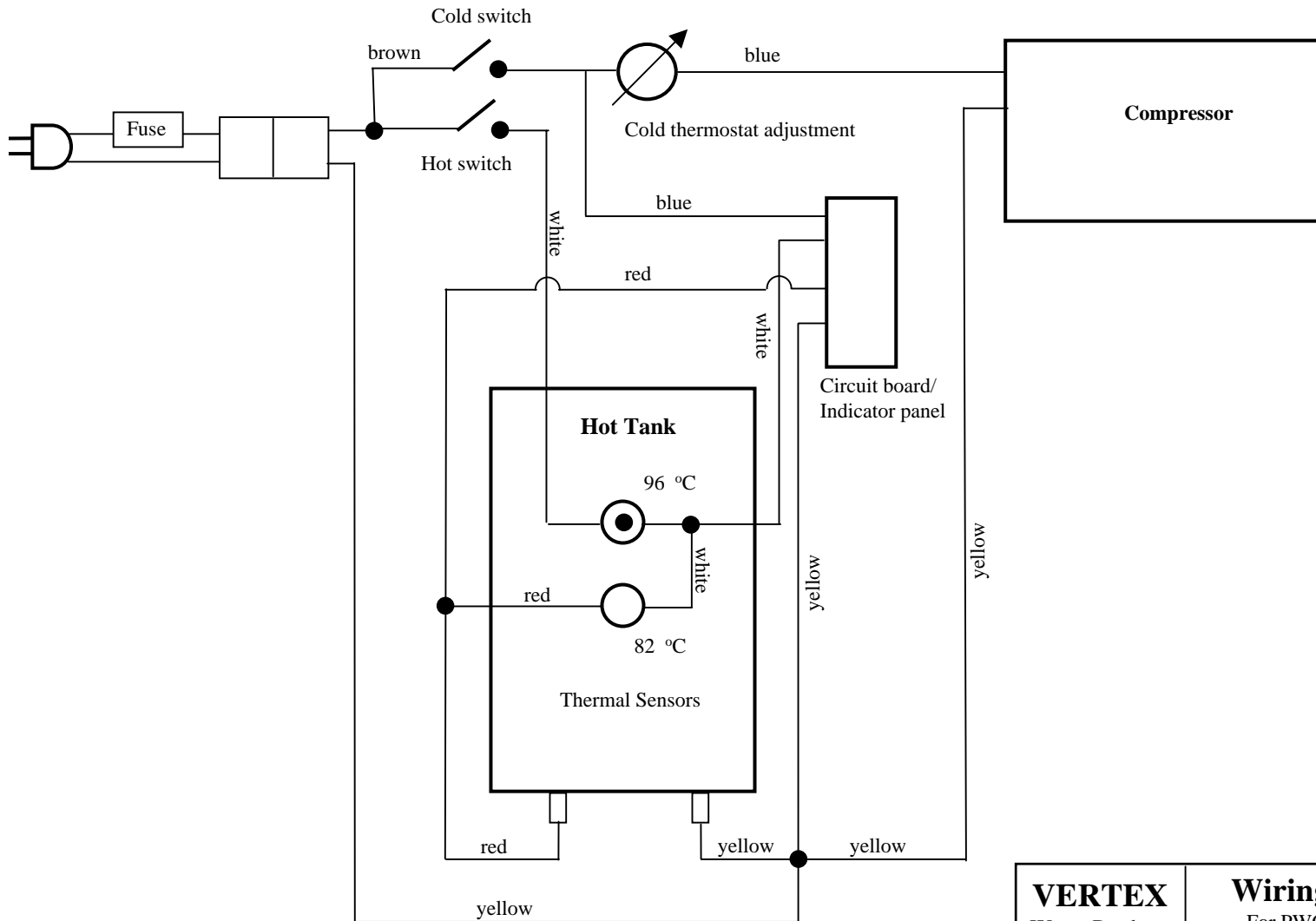

VERTEX Water Products Montclair, California		Wiring Diagram For PWC-1000 Cooler
	None Scale	CL1-10001 Dwg. No.
	10/10/05 Date	PWC-500-1500 Used on.

PWC-1000 Parts List

Item No.	Description	Part Number	Price
1	Top Cover	cl1- 9200	
2-1	Dust Cover	cl1- 9201	
3	Upper Front Panel	cl1- 9202	
4	Lower Front Door	cl1- 9203	
5	Base	cl1- 9204	
6	Drip Tray Base	cl1- 9205	
7	Drip Tray	cl1- 9206	
8	Hot Tap w/Safety	cl1- 9207	
9	Cold Tap	cl1- 9208	
10	Indicating Panel (sticker)	cl1- 9209	
11-1	Main Water Tank Cover	cl1- 9210	
12	Left Side Panel	cl1- 9211	
13	Right Side Panel	cl1- 9212	
14	Bracket	cl1- 9213	
15	Insulating Sleeve	cl1- 9214	
16	Spring Clip	cl1- 9215	
17	Screw 4 x 8 black	cl1- 9216	
18			
19			
20			
21	Mounting Plate	cl1- 9217	
22	Compressor	cl1- 9218	
23	Mounting Plate	cl1- 9219	
24	Faucet Bracket	cl1- 9220	
25	Bottom Insulator	cl1- 9221	
26	Upper Insulator	cl1- 9222	
27	Cold Water Tank	cl1- 9223	
28			
29	Silicon Gasket	cl1- 9224	

Item No.	Description	Part Number	Price
30	Silicon Vent "T"	cl1- 9225	
31	Silicon Tube Straight 250 x 2	cl1- 9226	
32	Silicon Tube Elbow 160 x 4	cl1- 9227	
33	Silicon Tube Elbow 50 x 60 x 4	cl1- 9028	
34	Hot Tank	cl1- 9029	
35			
36			
37	Silicon Tube Elbow, 175 x 4	cl1- 9230	
38	Screw, 3 x 8	cl1- 9231	
39	Vertex Emblem	cl1- 9232	
40	Mechanical Float Valve	cl1- 9233	
41	Tubing, 1/4"	cl1- 9234	
42	Handle	cl1- 9235	
43			
44	Rear Cover	cl1- 9236	
45	Cold Temperature Switch	cl1- 9237	
46	Power Switch	cl1- 9238	
47			
48	Condenser	cl1- 9239	
49	Drain Fitting Nut	cl1- 9240	
50	Dryer	cl1- 9241	
51			
52	Cold Tank Outlet Connector	cl1- 9242	
53	Tap Nut	cl1- 9243	
54	Silicon Tube SL-04	cl1- 9244	
55	Screw, Hot Tank	cl1- 9245	
56			
57	Tank Drain Connector	cl1- 9246	
58	Strain Relief	cl1- 9247	

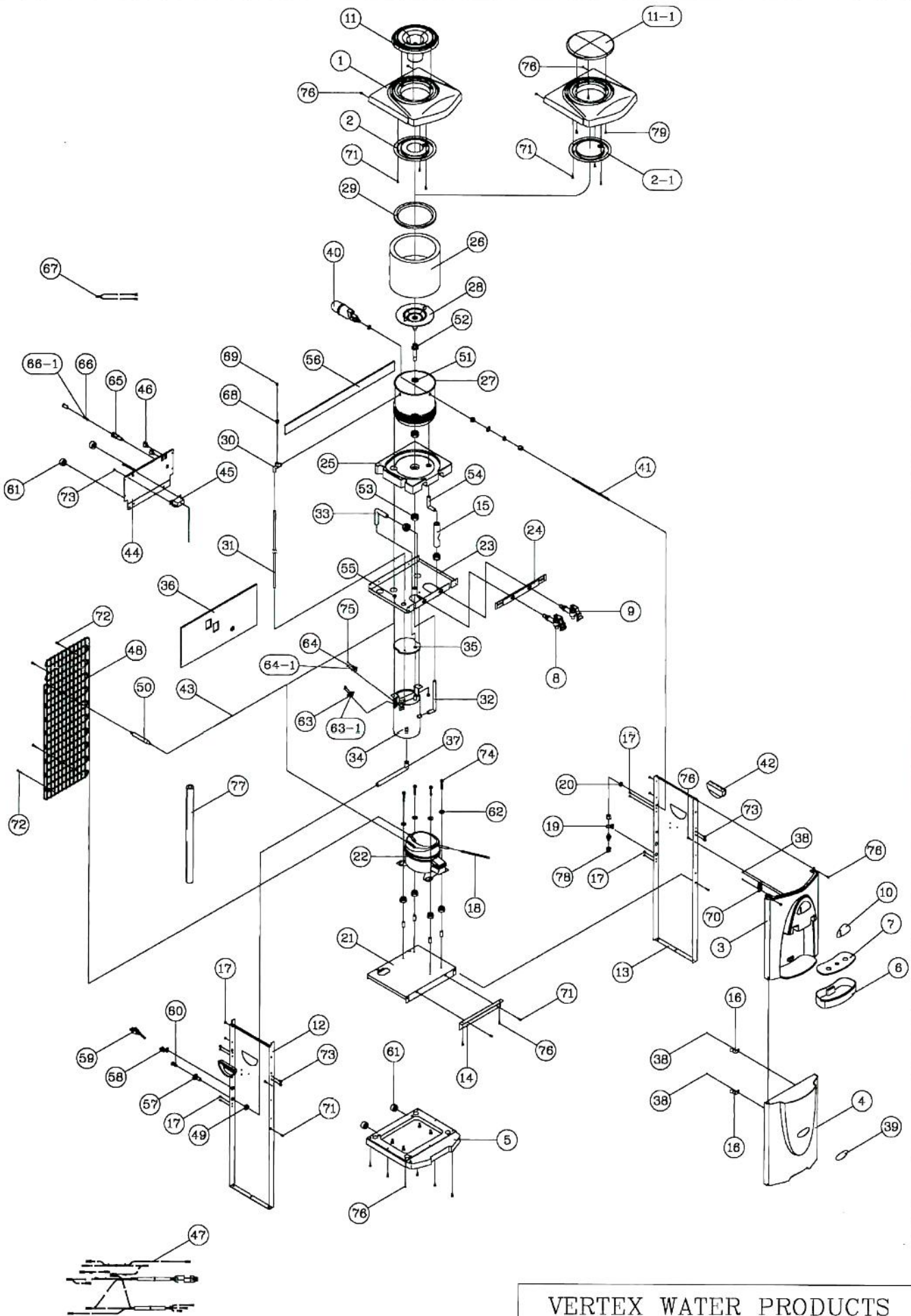

VERTEX WATER PRODUCTS
 PWC 1000

PWC-1500 Parts List

Item No.	Description	Part Number
H1	Hot Tank	cl5 9617
H2	96°C Temperature Sensor	cl1 9250
H3	82°C Temperature Sensor	cl1 9251
H4	Screw 5 x 22	cl1 9257
H5		
H6		
H7	Screw, Hot Tank	cl1 9245
H8	Silicon Tube Elbow, 175 x 4	cl1 9230
H9	Silicon Tube Elbow, 160 x 4	cl1 9227
H10	Silicon Tube St, 5 x 250	cl5 9618
H11	Silicon Vent "T" Tube	cl1 9225
H12		
H13		
H14	Silicon Tube Elbow 50x60x4	cl1 9028
H15	Drain Fitting Nut	cl1 9240
H16	Tank Drain Connector	cl1 9246
H17	Drain Plug	cl1 9248
H18	Silicon Plug	cl5 9619

Item No.	Description	Part Number
C1	Cold Water Tank	cl1 9223
C2		
C3	Silicon Gasket	cl1 9224
C4	Cold Tank Outlet Connector	cl1 9242
C5		
C6	Nut, Faucet	cl5 9620
C7	Insulating Foam, Cold Tank	cl1 9222
C8	Bottom Insulating Foam	cl5 9621
C9		
C10	Silicon Tube Elbow, 75 x 4	cl1 9244
C11	Insulating Sleeve	cl1 9214

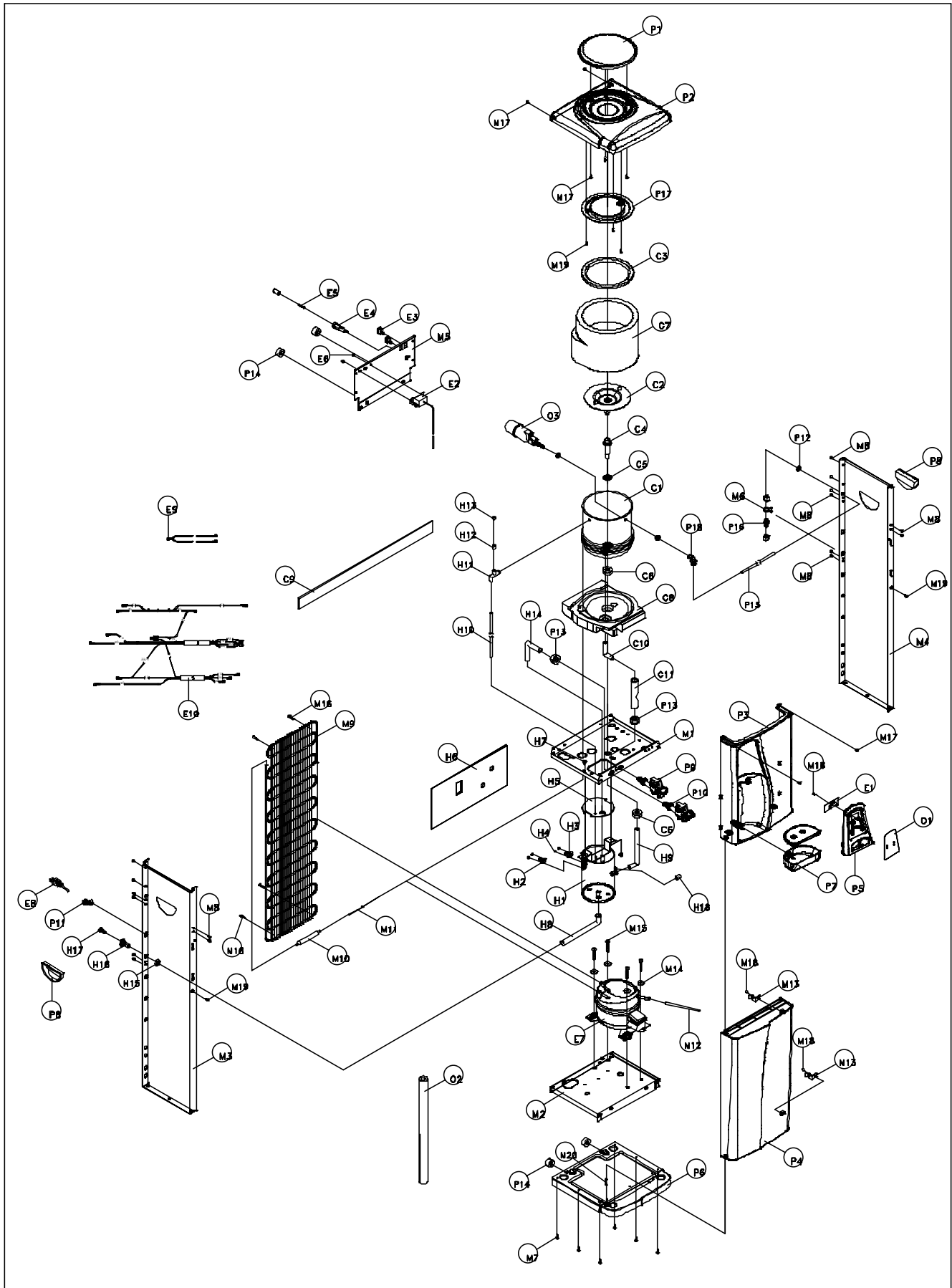

VERTEX WATER PRODUCTS
PWC-1500